

PREFABBRICATI

PREZENTACJA ELEMENTÓW

SŁUPY

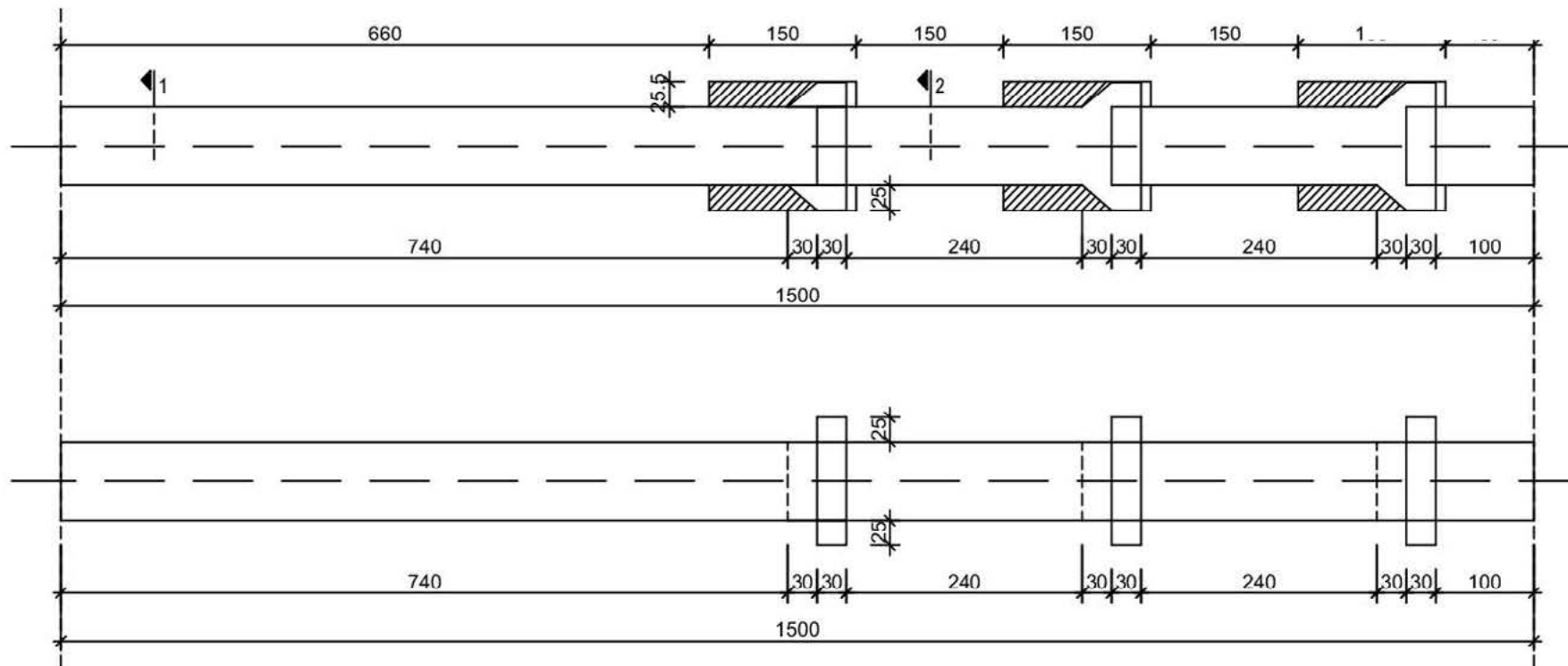

PRZEKRÓJ 1-1

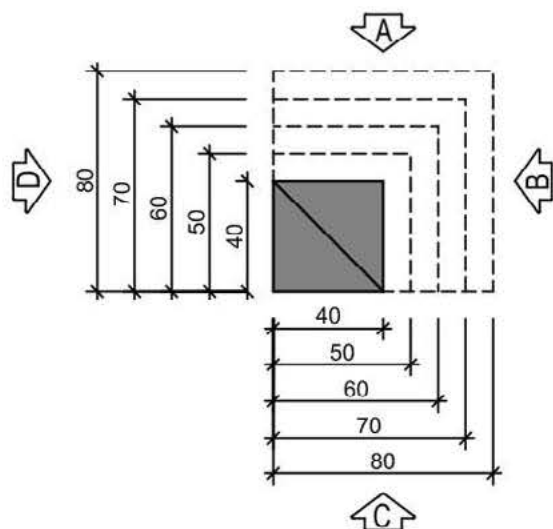

PRZEKRÓJ 2-2

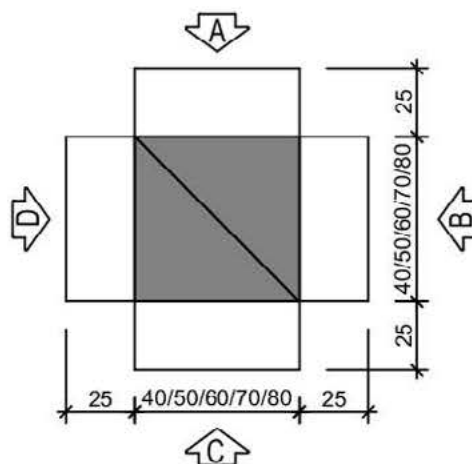

BELKI - SPREŻONE LUB MONOLITYCZNE

BELKA TR

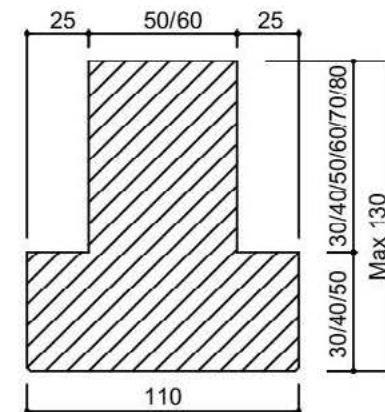
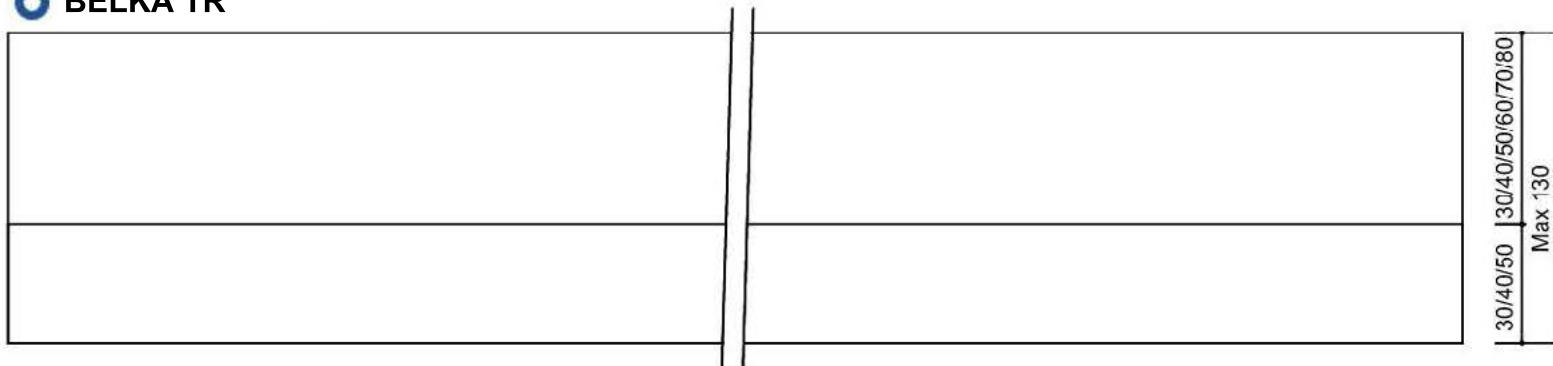

BELKA TL

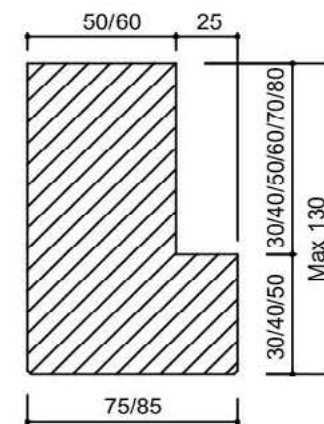
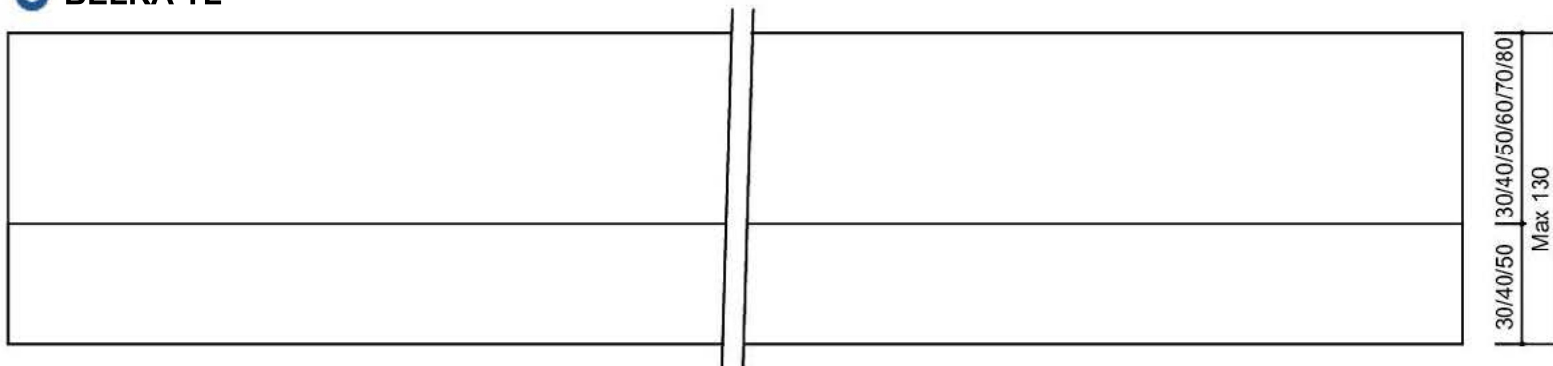

BELKA R

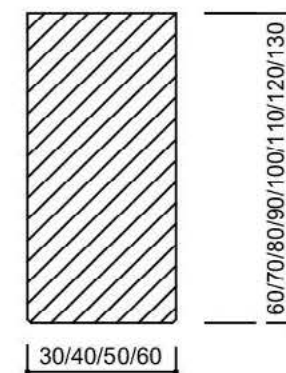
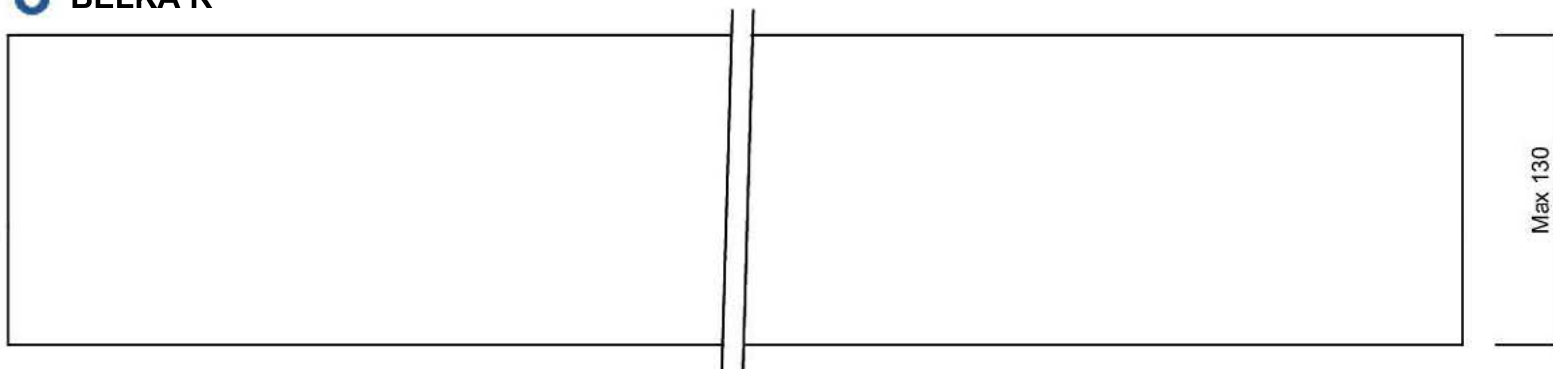

DŹWIGARY DACHOWE

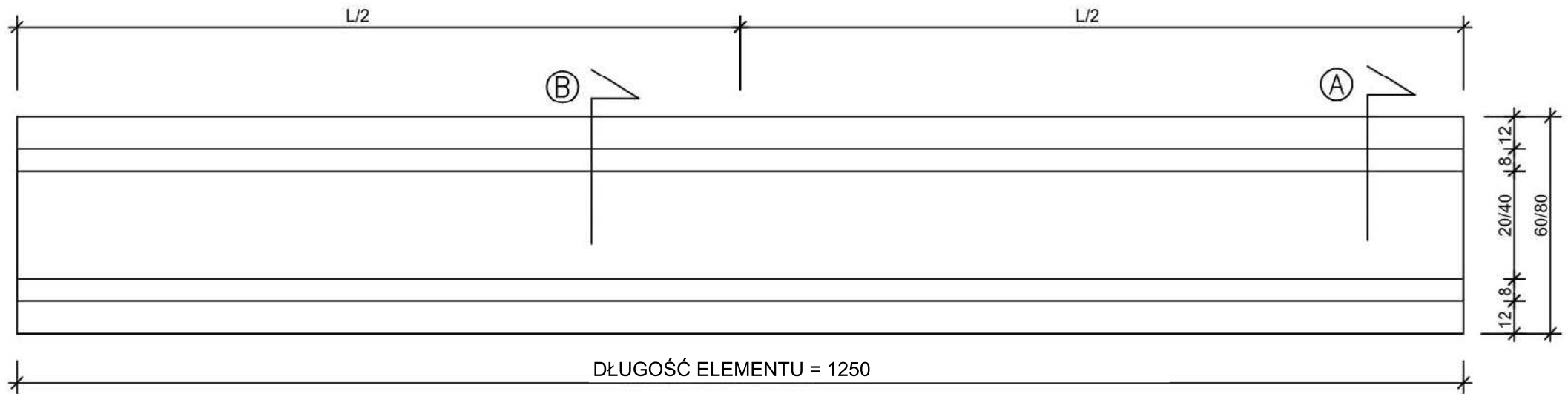

PRZEKRÓJ A-A

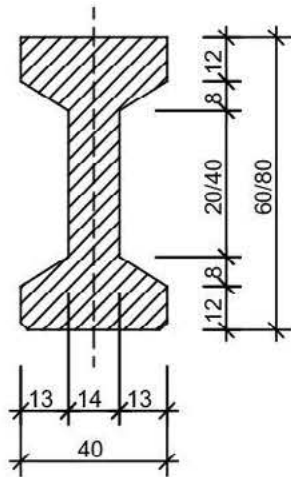

PRZEKRÓJ B-B

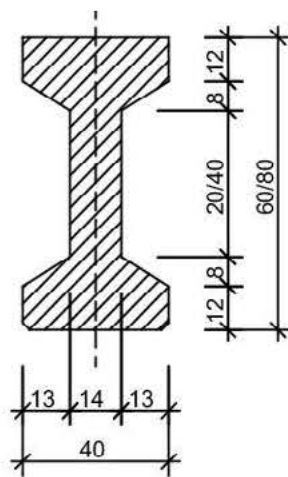

- BELKA I - 60 cm x 6 - 10 m
- BELKA I - 80 cm x 8 - 12 m

DŹWIGARY DACHOWE

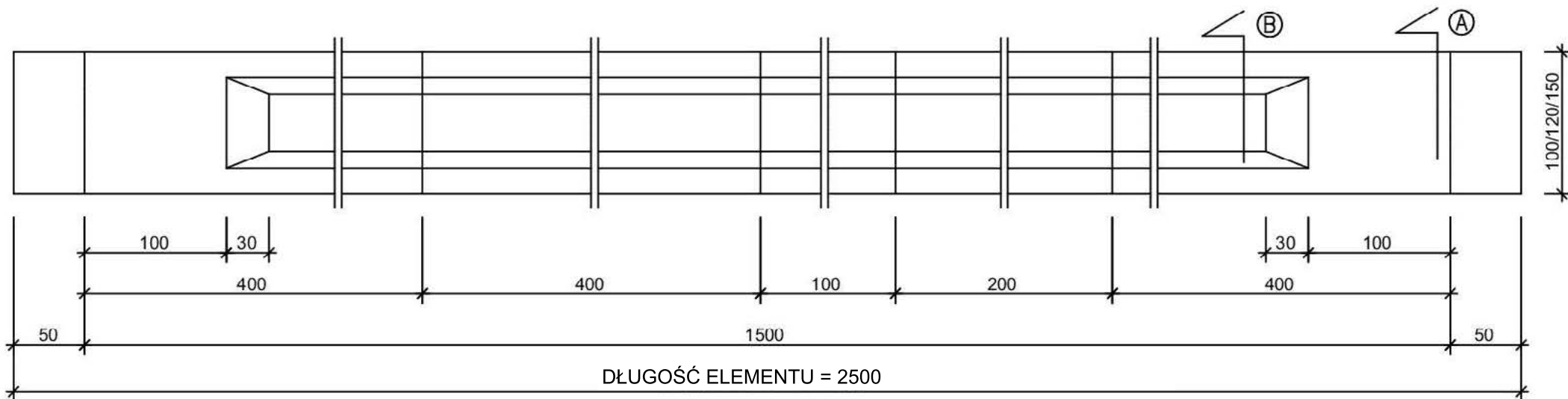

PRZEKRÓJ B-B

PRZEKRÓJ A-A

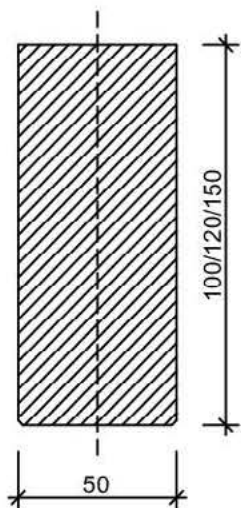

TYP A

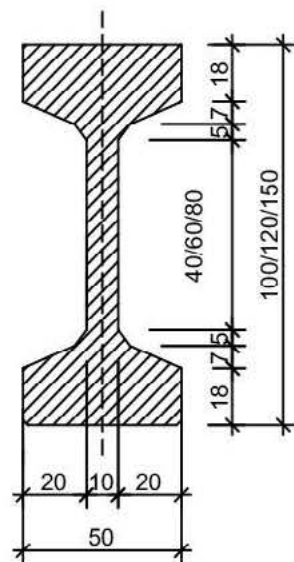

TYP B

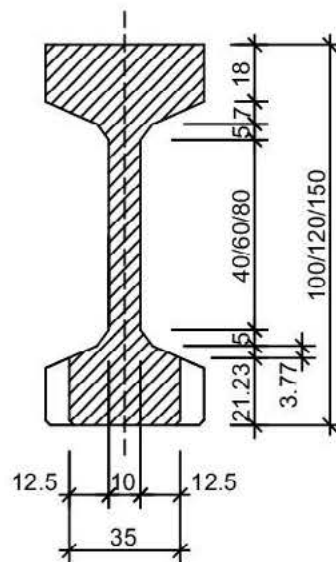

- BELKA I - 100 cm x 10 - 15 m; TYP A/B
- BELKA I - 120 cm x 12 - 18 m; TYP A/B
- BELKA I - 150 cm x 15 - 25 m; TYP A/B

DŹWIGARY DACHOWE

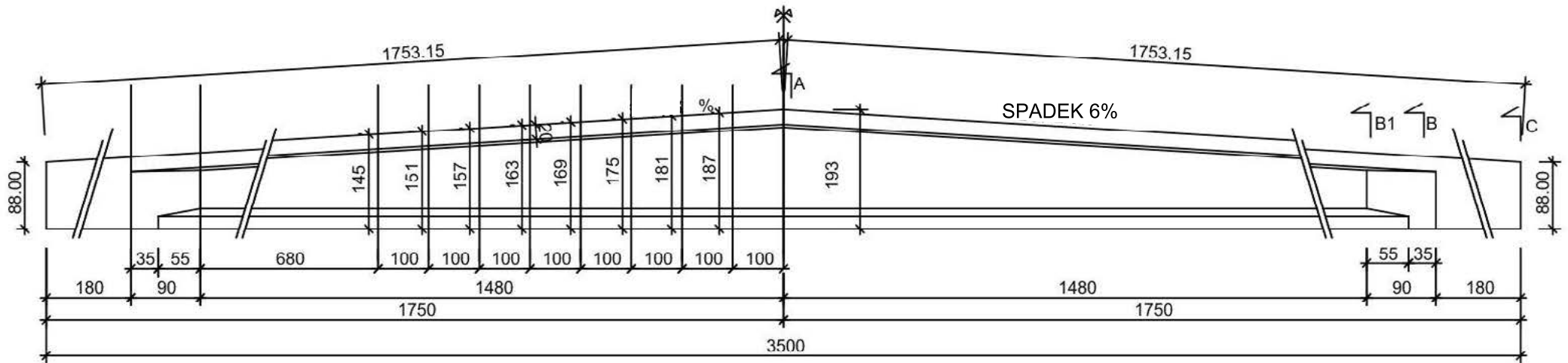

PRZEKRÓJ A-A
TYP 1

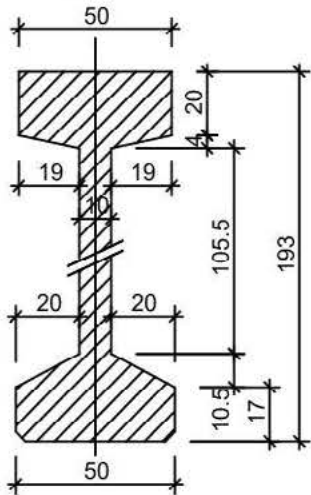

PRZEKRÓJ A-A
TYP 2

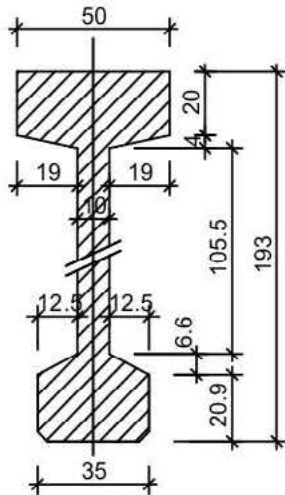

PRZEKRÓJ B-B

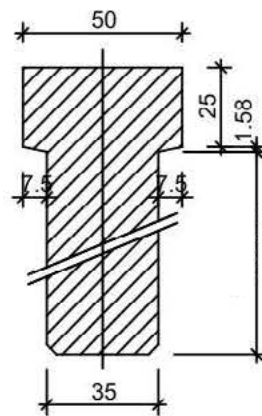

PRZEKRÓJ B1-B1

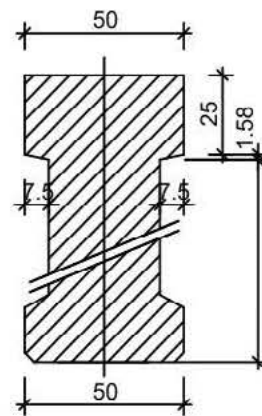

PRZEKRÓJ C-C

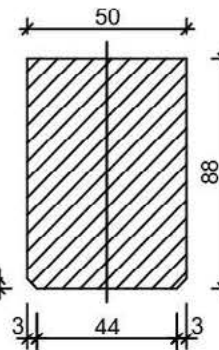

● DŹWIGAR DWUSPADOWY
TYP 1
(6%, 17 - 35 m)

● DŹWIGAR DWUSPADOWY
TYP 2 - LEKKI
(6%, 17 - 35 m)

PŁYTY T-T

○ PŁYTY T-T - ROZPIĘTOŚĆ 4 - 22 m

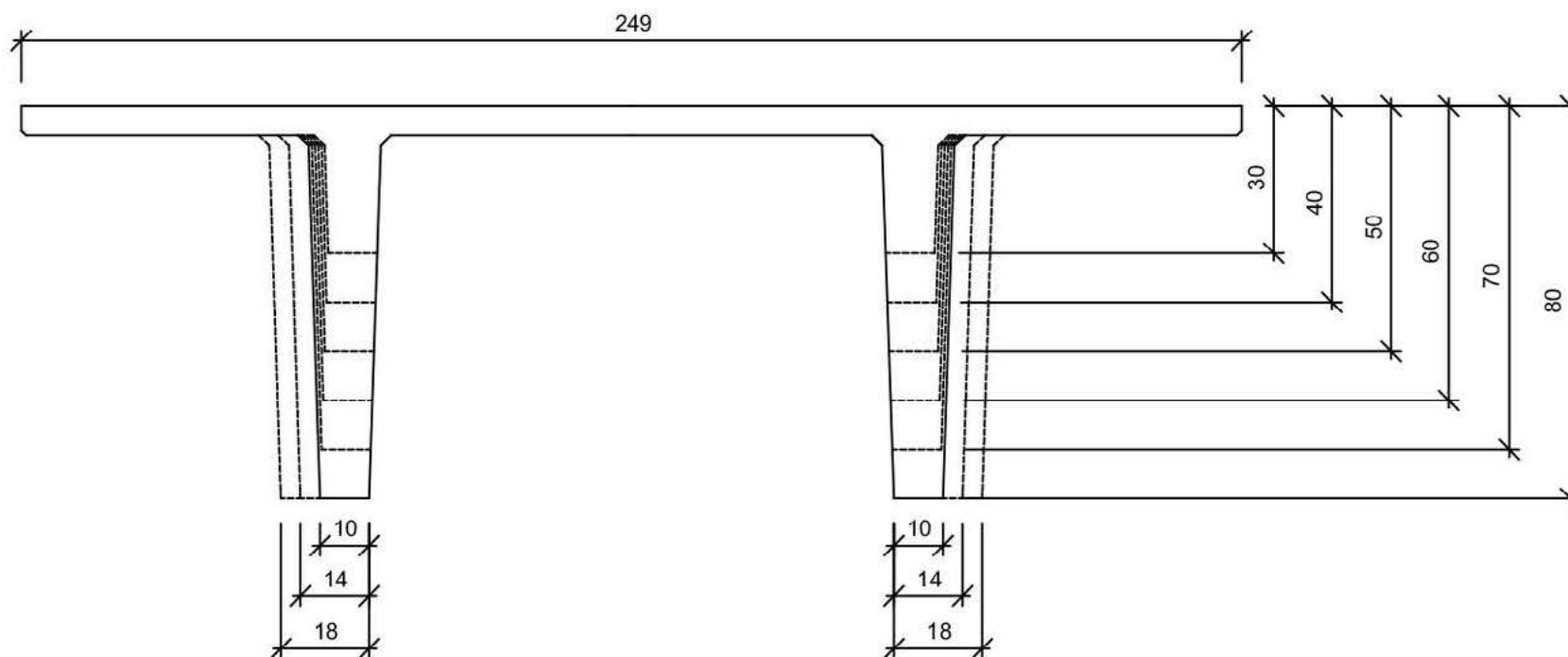

PŁATWIE

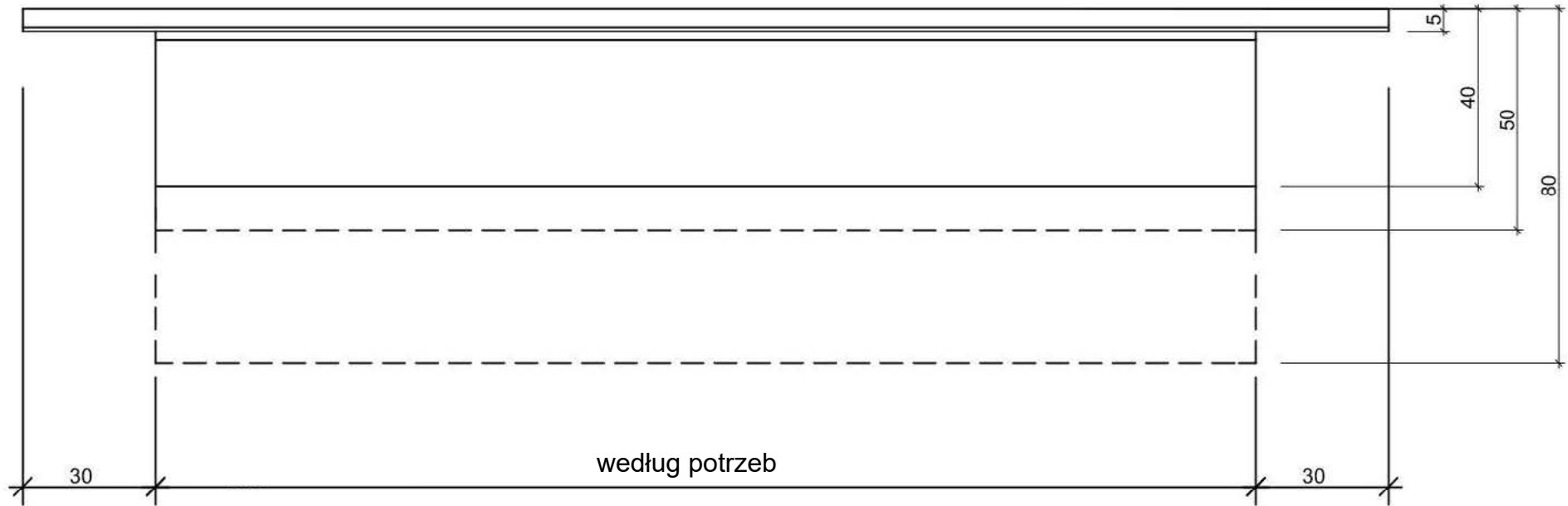

PŁATEW 80

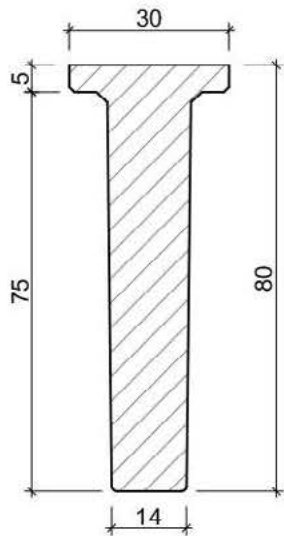

PŁATEW 50

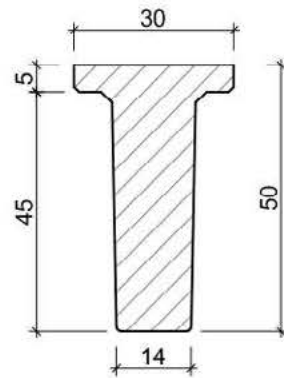

PŁATEW 40

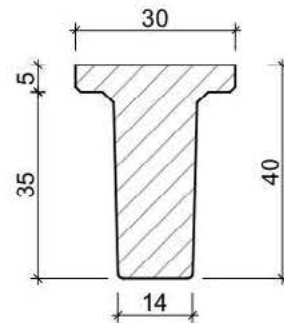

- PŁATEW 40 (od 6 do 12 m)
- PŁATEW 50 (od 10 do 16 m)
- PŁATEW 80 (od 16 do 22 m)

PREFABBRICATI

📍 **Prefabbricati sp. z o.o.**
97-200 Tomaszów Maz., ul. Warszawska 128/130
NIP: 7732496783

📍 **Adres zakładu:**
Prefabbricati sp. z o.o.
97-200 Łazisko, ul. Łazisko 50F



prefabbricati.pl